

# Physics

## Unit 1&2

– Semester 2, 2018

STUDENT NAME: \_\_\_\_\_

TEACHER NAME (circle correct one):

### Time allowed for this paper

Reading time before commencing work: 10 minutes  
Working time for paper: 2.5 hours

### Material required/recommended for this paper

#### To be provided by the supervisor

This Question/answer booklet  
Formulae and Data booklet

#### To be provided by the candidate

Standard items: pens (non-erasable), pencils (including coloured), sharpener, eraser, correction fluid, ruler, highlighters  
Special items: up to three non-programmable calculators approved for use in the WACE examinations, drawing templates, drawing compass and a protractor.

### Important note to candidates

No other items may be taken into the examination room. It is **your** responsibility to ensure that you do not have any unauthorised notes or other items of a non-personal nature in the examination room. If you have any unauthorised material with you, hand it to the supervisor **before** reading any further.

### Structure of this paper

Section	Number of questions available	Number of questions to be answered	Suggested working time (minutes)	Marks available	Percentage of exam
Section One: Short response	13	13	42	45	30

Section Two: Problem-solving	5	5	75	75	50
Section Three: Comprehension	2	2	33	30	20
<b>Total</b>					<b>100</b>

### ***Instructions to candidates***

1. The rules for the conduct of WACE examinations are detailed in the *Student Information Handbook*. Sitting this examination implies that you agree to abide by these rules.
2. Answer **all** questions in the spaces provided in this Question/Answer Booklet. The value of each question (out of 150) is shown following each question.
3. The enclosed Physics: Formulae and Constants Sheet may be removed from the booklet and used as required.
4. A blue or black ballpoint or ink pen should be used.
5. Calculators satisfying conditions set by the School Curriculum and Standards Authority may be used to evaluate numerical answers. The calculator **cannot** be a “**graphics**” calculator.
6. Answers to questions involving calculations should be evaluated and given in decimal form. Final answers should be given to **three significant figures** and include appropriate units where appropriate. Despite an incorrect final result, credit may be obtained for method and workings, providing these are clearly and legibly set out.
7. Questions containing specific instructions to **show working** should be answered with a complete, logical, clear sequence of reasoning showing how the final answer was arrived at; correct answers which do not show working will not be awarded full marks.
8. Questions containing the instruction “**ESTIMATE**” may give insufficient numerical data for their solution. Show your working or reasoning clearly. Give final answers to **two significant figures** and include appropriate units where applicable.
9. Spare pages are included at the end of the question/answer booklet. They can be used for planning your responses and/or as additional space if required to continue an answer.
  - Planning: If you use the spare pages for planning, indicate this clearly at the top of the page.
  - Continuing an answer: If you need to use the space to continue an answer, indicate in the original answer space where the answer is continued, i.e. give the page number. Fill in the number of the question(s) that you are continuing to answer at the top of the spare page.

**SECTION ONE: Short Response****30% (45 marks)**

This section has **thirteen (13)** questions. Answer in the spaces provided.

Suggested working time: **42 minutes**.

**Question 1****(3 marks)**

A new saucepan has been designed that heats up food much faster than a traditional saucepan. The figure below shows the two saucepans.

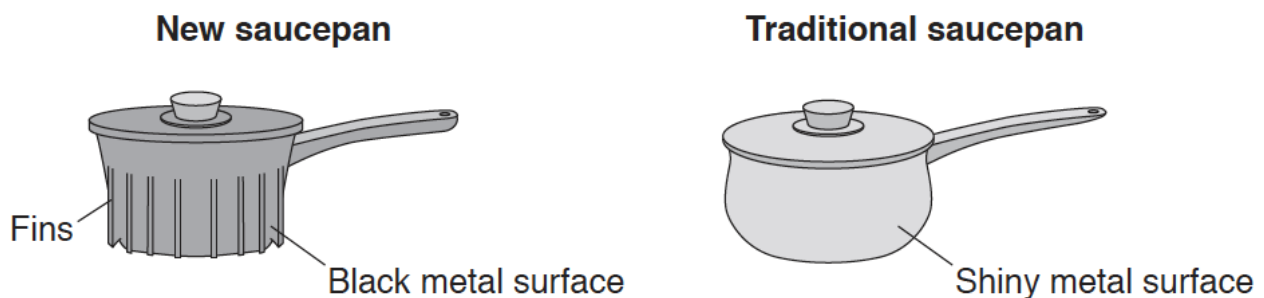

- (a) Describe how the features of the new saucepan cause the food to heat up faster than when the food is heated in the traditional saucepan. (2 marks)

Fins:

Black metal surface:

The colour black is good at absorbing heat through radiation meaning that when the metal surface is black, more heat will be absorbed by the saucepan resulting in food heating up faster

- (b) Suggest another modification that would make a traditional saucepan more efficient. (1 mark)

**Question 2**

**(3 marks)**

Explain, including units, the difference between Specific Heat Content and Latent Heat.

The specific heat capacity is the amount of energy in joules that it takes to increase the temperature of a certain material by 1 degree Celsius.

Latent heat is the amount of energy in joules that is absorbed or released during the state of a material

**Question 3**

**(3 marks)**

A sample of solid copper is heated beyond its melting point. The graph shows the variation of temperature with time.

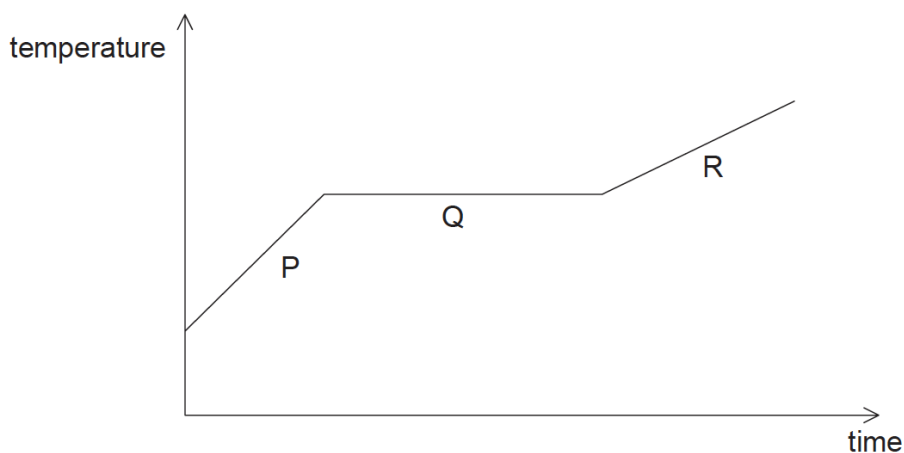

During which stage(s) is there....

- (a) an increase in total internal energy? \_\_R\_\_
- (b) an increase in average potential energy? \_\_Q\_\_
- (c) an increase in average kinetic energy? \_P\_

**Question 4**

**(2 marks)**

Alpha decay of  $^{226}\text{Ra}$  is part of the decay series of  $^{238}\text{U}$ . The product of this decay was first identified by the Curies. Write the complete decay equation and name the radioisotope produced in the decay.

Name of isotope produced: \_\_\_\_\_

**Question 5**

**(4 marks)**

The diagram below shows the fission of U-235 by the absorption of a slow moving neutron.

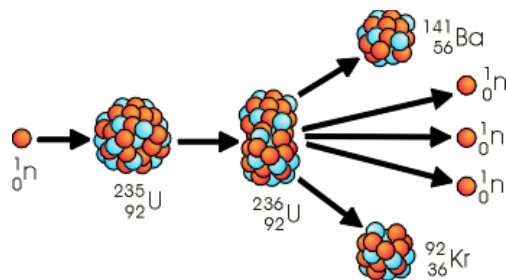

(a) Could this process produce a *chain reaction*? Explain. (2 marks)

- The reaction occurs when a neutron collides with U-235
- This results in the formation of Kr-92, Ba-141 and 3 neutrons
- These 3 neutrons could then return collide with more U-235
- This could result in a chain reaction

(b) Describe the difference between artificial and spontaneous nuclear transmutation (2 marks)

### Question 6

(4 marks)

During a flight from New York to London, a 60.0 kg woman absorbs 85.5  $\mu\text{Gy}$  of gamma radiation.

(a) Calculate the amount of radiation energy absorbed during the flight. (2 marks)

(b) Calculate the dose equivalent of the radiation absorbed. (2 marks)

## Question 7

(4 marks)

Four resistors are connected to a 12.0 V cell as shown below.

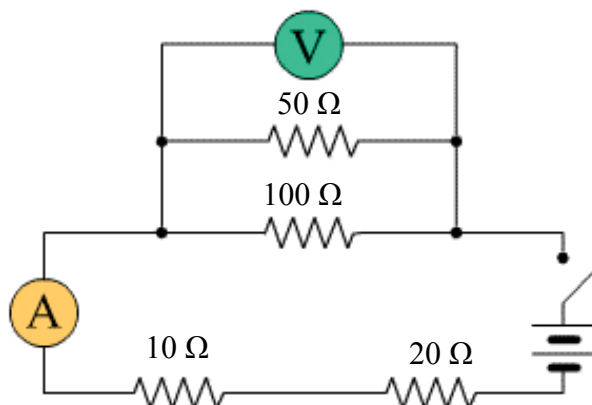

Calculate the values recorded by the ammeter and voltmeter pictured.

## Question 8

(3 marks)

An elevator (lift) and its load have a total mass of 750 kg and accelerate vertically downwards at  $2.0 \text{ m s}^{-2}$ .

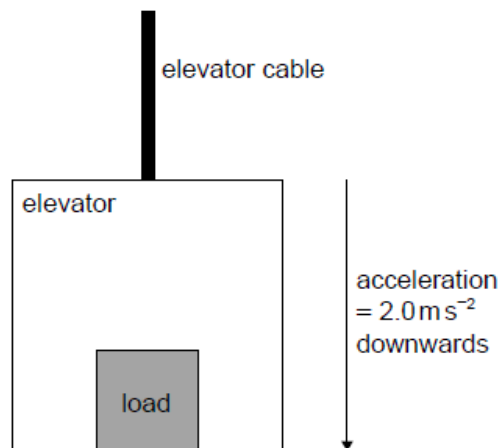

Calculate the tension in the elevator cable.

## Question 9

(4 marks)

A ball travelling at  $5.00 \text{ m s}^{-1}$  strikes the ground at  $25^\circ$  and rebounds at the same speed at  $25^\circ$  to the ground. Calculate the change in velocity of the ball, using a suitable vector diagram.

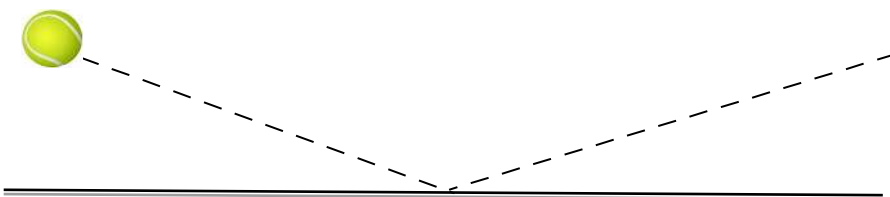

Question 10

(2 marks)

A group of physics teachers is taking some time off for a little mini-golf. The 15th hole has a large metal rim that putters must use to guide their ball towards the hole. Mr. Davey guides a golf ball around the metal rim. When the ball leaves the rim, which path (1, 2, or 3) will the golf ball follow? Explain your answer with reference to one of Newton's Laws of motion.

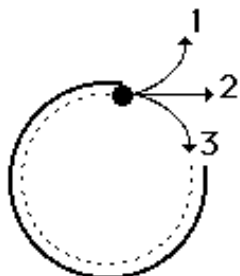

- The ball should take path 2
- This is due to Newton's first law
- As there is no longer any external imbalanced force acting upon golf ball
- It will maintain its motion and move forward in a straight line

---



---



---



---



---

Question 11

(4 marks)

Two Physics students were conducting an experiment with dynamics carts. Cart B has twice the mass of cart A. The two carts are originally at rest. A small spring expands rapidly, causing the two carts to move away from each other.

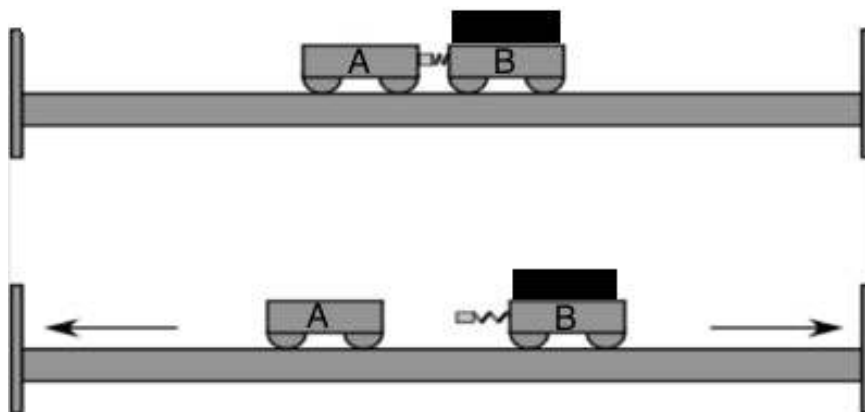

The two students made the following statements. Identify the statements as True (T) or False (F).

Cart A's speed was greater than cart B's speed after the expansion.	T
The magnitude of Cart A's momentum was greater than the magnitude of the momentum for cart B after the expansion.	F
Cart A experienced a larger magnitude of force than Cart B during the expansion.	F
The kinetic energy of each cart is the same after the expansion.	F



## Question 12

(6 marks)

A signal generator is set to vibrate at 60.0 Hz and is attached to a length of elastic. The elastic is kept at a constant tension and its effective length is 2.10 m. A standing wave is established as shown in the diagram.

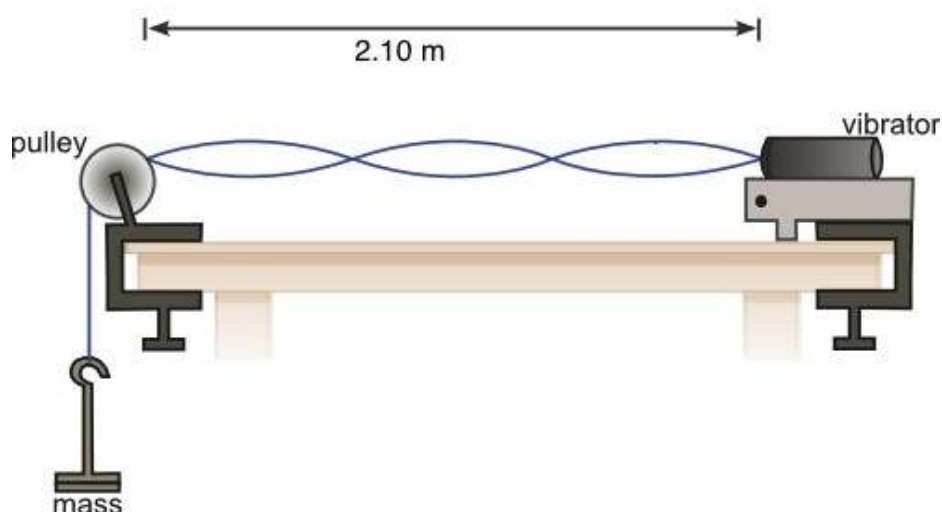

- (a) At which harmonic is the spring vibrating? \_\_\_\_\_ (1 mark)
- (b) Calculate the wavelength of the wave and hence calculate the velocity of the wave along the along the elastic. (2 marks)
- (c) On the diagram above, label a node (n) and in the space below, explain how a node is formed. (3 marks)

- When two waves are the exact same in frequency and amplitude that are heading in the exact opposite direction, superimpose to create destructive interference
- This creates a node, a place with no amplitude

---



---



---



---

**Question 13****(3 marks)**

Gemma is at an outdoor concert and is 25.0 m from the stage. She decides to measure the sound intensity and finds that it is  $5.00 \times 10^{-4} \text{ Wm}^{-2}$ . She sees some friends who are 15.5 m from the stage and decides to join them. Calculate the expected sound intensity at this new location.

**End of Section One**

**SECTION TWO: Problem-solving****50% (75 marks)**This section has **five (5)** questions. Write your answers in the spaces provided.Suggested working time: **75 minutes**.**Question 14****(19 marks)**

The graph shows the variation with time  $t$  of the speed  $v$  of a ball of mass  $0.50\text{ kg}$ , that has been released from rest above the Earth's surface.

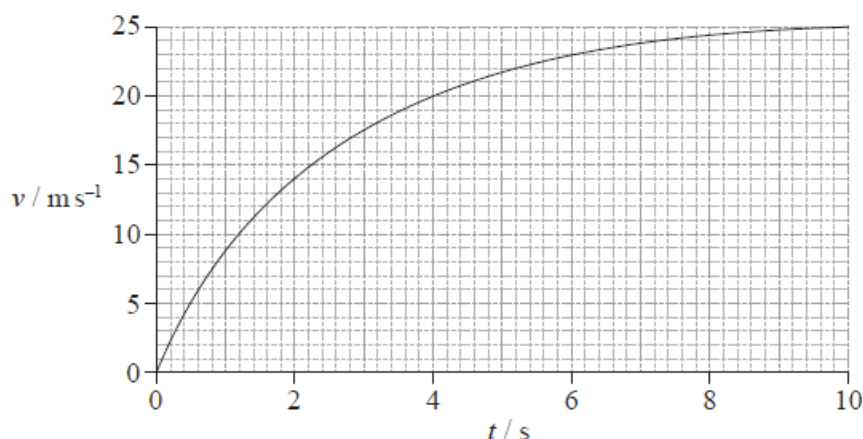

(a) Explain why the graph is non-linear, although  $g$  is a constant  $9.80\text{ m s}^{-2}$  during its fall. (2 marks)

- This is because, as an object is falling, it has a weight force and a reaction force is formed in the form of air resistance
- The air resistance continues until it is equal to the weight force, resulting in acceleration being 0 which means that velocity remains the same
- Due to air resistance, the acceleration decreases, which causes velocity to be non-linear

(b) State, without any calculations, how the graph could be used to determine the distance fallen. (1 mark)

The area under the graph can be used to calculate displacement

(c) In the space below, draw and label arrows to represent the forces on the ball at  $2.0\text{ s}$ . (2 marks)



- (d) Use the graph to show that the acceleration of the ball at 2.0 s is approximately  $4 \text{ ms}^{-2}$ .  
**Show full working.** (3 marks)

- (e) Calculate the magnitude of the force of air resistance on the ball at 2.0 s. (2 marks)

- (f) State and explain why the air resistance on the ball at  $t = 5.0 \text{ s}$  is smaller than, equal to **or** greater than the air resistance at  $t = 2.0 \text{ s}$ . (2 marks)
- 
- 

After 10 s the ball has fallen 190 m.

- (g) Show that the sum of the potential and kinetic energies of the ball has decreased by 775 J. (4 marks)

- (h) The specific heat capacity of the ball is  $480 \text{ J kg}^{-1} \text{ K}^{-1}$ . Estimate the increase in the temperature of the ball. State any assumptions that you make. (3 marks)

## Question 15

(17 marks)

The diagram shows the variation of nuclear binding energy per nucleon with nucleon number for some of the lighter nuclides.

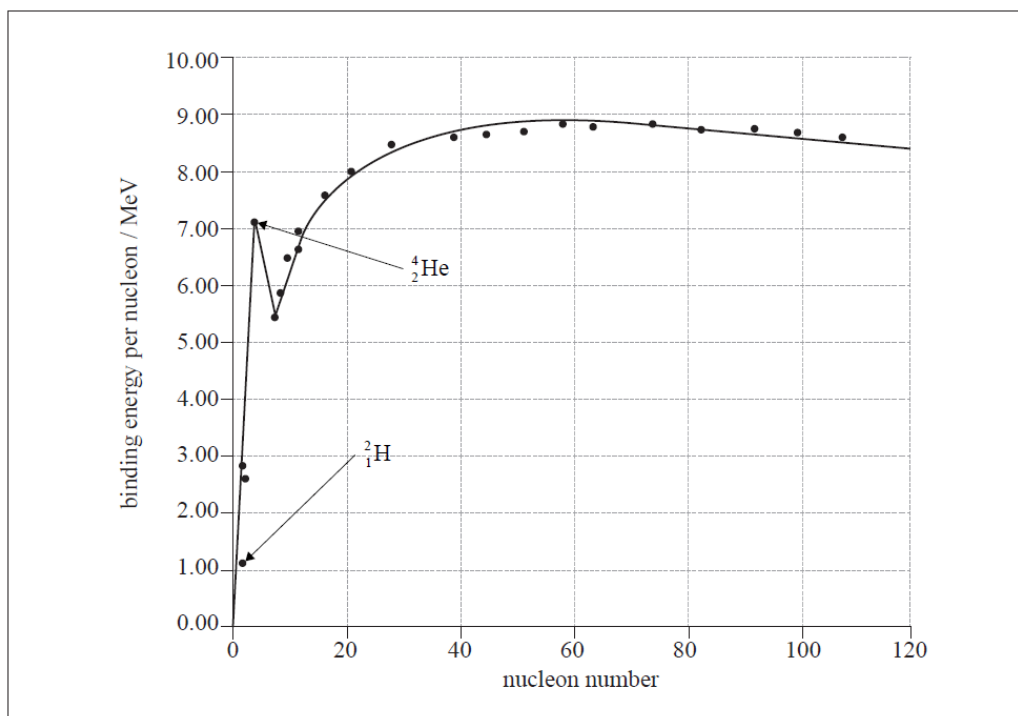

- (a) Outline, with reference to mass defect, what is meant by the term nuclear binding energy. (2 marks)

Binding energy of a particle is the amount of energy that is required to hold the particle together  
The mass defect of an object is direction proportionate to the energy required to hold the object together

- (b) Label, with the letter **S**, the region on the graph where nuclei are most stable. (1 mark)

- (c) Deuterium is an isotope of hydrogen with the formula. Show that the energy released when two nuclei fuse to make a nucleus is approximately 4 pJ (4 picojoules). (4 marks)

The mass of a  $\alpha$  atom is 2.10 u.

- (d) Calculate the mass of a  $\alpha$  atom in kg? (1 mark)
- (e) Calculate the number of deuterium atoms in 1.50 kg of deuterium. (1 mark)
- (f) Show that the amount of energy released by the fusion of 1.50 kg of deuterium is approximately  $8 \times 10^{14}$  J. (2 marks)

In a trial fusion reactor, this energy is used to convert liquid water into superheated (very hot) steam. This conversion process is 75% efficient.

- (g) Calculate the amount of energy available for the conversion of water into superheated steam. (1 mark)
- (h) The liquid water has an original temperature of  $18.0^\circ\text{C}$  and the final temperature of the superheated steam is  $150^\circ$ . Calculate the mass of liquid converted to superheated steam for every 1.50 kg of deuterium fuel undergoing fusion. (5 marks)

## Question 16

(15 marks)

Some strings of holiday lights are wired in series to save wiring costs. An old version utilised bulbs that break the electrical connection, like an open switch, when they burn out.



- (a) If one such bulb burns out, what happens to the others? Explain. (2 marks)

The bulbs are connected in series meaning that when one globe breaks, the circuit breaks and therefore, current will not flow through the lightbulb

---

---

One string of lights operates on 240 V and has 20 identical bulbs, connected in series. The entire string of lights is rated at 120 W.

- (b) What current is drawn by the string of lights? (2 marks)

- (c) What is the normal operating voltage of each bulb? (1 mark)

- (d) Show that the resistance of each bulb is  $24 \Omega$ ? (1 marks)

The 20 bulbs were reconnected so that there are 5 sets of 4 bulbs. The sets of 4 bulbs were all wired in parallel and the 5 sets of these bulbs were in turn connected in series.

- (e) Draw a circuit diagram for this configuration. (2 marks)

- (f) If the new configuration is still required to have a power rating of 120 W, show that the required supply voltage for this configuration is approximately 60 volts. (3 marks)

The 20 bulbs were then reconnected so that there are 2 sets of 10 bulbs. The sets of 10 bulbs were all wired in series and the 2 sets of these bulbs were in turn connected in parallel.

- (g) If this new configuration was then connected to 240 V, how would the brightness compare the configuration described at the beginning of the question. Use calculations to support your answer. You should assume that the bulbs do not blow. (2 marks)

- (h) Can the same fuse be used after the string of lights has been rewired into this parallel configuration? Explain with use of a calculation. (2 marks)



## Question 17

(12 marks)

A snowboarder starts from rest at point A as shown in the figure below.

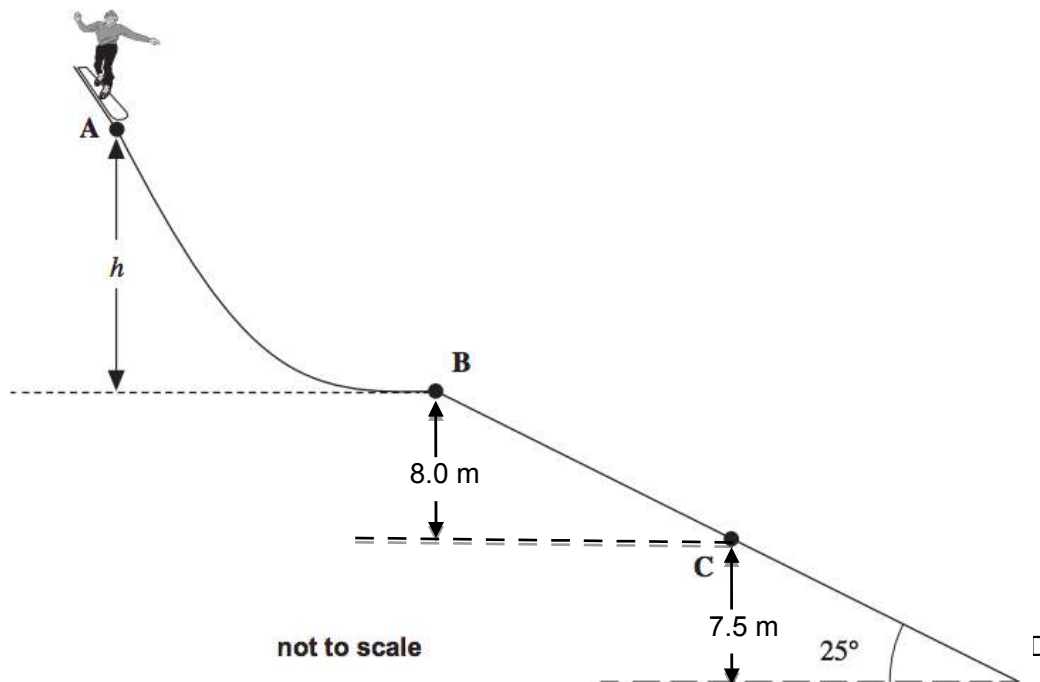

The snowboarder and board have a combined mass of 65 kg and the effects of friction and air resistance are negligible.

The snowboarder has a speed of  $21.0 \text{ m s}^{-1}$  at point B.

- (a) Calculate the height difference,  $h$  between points A and B. (2 marks)
- (b) The snowboarder becomes airborne at point B and lands at point C, which is 8.0 m below point B. Find the snowboarder's speed at C. (3 marks)

- (c) At point C, the snowboarder digs her board into the snow as she moves from point C to point D, which is 7.5 m below point C. The force from her board digging into the snow, causes her to come to rest at point D. Find the average force applied by the board digging into the snow. (5 marks)
- (d) Suggest why it is safer for the snowboarder to land on a downward slope, rather than on a horizontal surface. Explain with appropriate Physics. (2 marks)

Question 18

(12 marks)

During an experiment, a 400 Hz sound is emitted from a loudspeaker next to a wall. The loudspeaker emits a sound wave that is highly directional. This means that the wavefronts are quite narrow as shown in the diagram below. A, B and C are wavefronts emitted by the speaker.

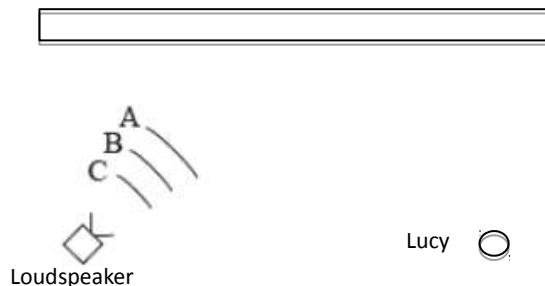

- (a) Draw rays on the above diagram to show how Lucy is able to hear the sound from the loudspeaker. (2 marks)
- (b) Show that the wavelength of the sound is 86.5 cm. (1 mark)

The experiment is then modified and a second speaker is added as shown below.

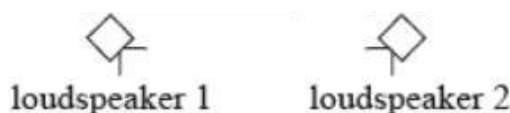

- (c) Tony, one of the experimenters stands at a point that is 3.0 m from both speakers and notices that the sound is quite loud. However, when he moved to a point that was 3.0 m from speaker 1 and 3.43 m from speaker 2, he found there to be very little sound. Explain these observations. (3 marks)

---

---

---

---

---

---

---

---

A few meters from where the experiment was taking place a 2.6 m section of water pipe was being lowered to the ground by a crane. Tony wanted to see if he could establish a standing wave in the pipe, so he pointed one of the

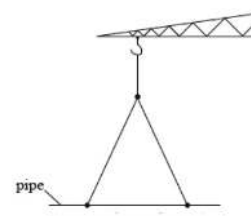

speakers directly at one of the open ends of the pipe and noticed that the sound became considerably louder.

- (d) Explain this observation. For full marks, your explanation must be accompanied by a sketch any standing waves formed. (4 marks)

- (e) On a hotter day Tony would have to use a different frequency sound to produce the same effect from the pipe. Explain. (2 marks)

**End of Section Two**

**SECTION THREE: Comprehension****20% (30 marks)**

This section has **two (2) questions**. You must answer **both** questions. Write your answers in the spaces provided.

Suggested working time: **33 minutes**.

**Question 19****(15 marks)**

Read the following article and then answer the questions that follow.

**Ultrasound**

Article adapted from *College Physics* ISBN-10: 1938168003



**Figure 1.** Ultrasound is used in medicine to painlessly and noninvasively monitor patient health and diagnose a wide range of disorders. (credit: abbybatchelder, Flickr)

Any sound with a frequency above 20,000 Hz (or 20 kHz)—that is, above the highest audible frequency—is defined to be ultrasound. In practice, it is possible to create ultrasound frequencies up to more than a gigahertz. (Higher frequencies are difficult to create; furthermore, they propagate poorly because they are very strongly absorbed.) Ultrasound has a tremendous number of applications, which range from burglar alarms to use in cleaning delicate objects to the guidance systems of bats. We begin our discussion of ultrasound with some of its applications in medicine, in which it is used extensively both for diagnosis and for therapy.

**CHARACTERISTICS OF ULTRASOUND**

The characteristics of ultrasound, such as frequency and intensity, are wave properties common to all types of waves. Ultrasound also has a wavelength that limits the fineness of detail it can detect. This characteristic is true of all waves. We can never observe details significantly smaller than the wavelength of our probe; for example, we will never see individual atoms with visible light, because the atoms are so small compared with the wavelength of light.

### Ultrasound in Medical Therapy

Ultrasound, like any wave, carries energy that can be absorbed by the medium carrying it, producing effects that vary with intensity. When focused to intensities of  $10^3$  to  $10^5$  W/m<sup>2</sup>, ultrasound can be used to shatter gallstones or pulverize cancerous tissue in surgical procedures. (See Figure.) Intensities this great can damage individual cells, variously causing their protoplasm to stream inside them, altering their permeability, or rupturing their walls through *cavitation*. Cavitation is the creation of vapor cavities in a fluid—the longitudinal vibrations in ultrasound alternatively compress and expand the medium, and at sufficient amplitudes the expansion separates molecules. Most cavitation damage is done when the cavities collapse, producing even greater shock pressures.

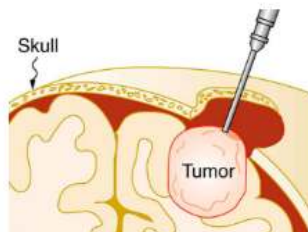

**Figure 2.** The tip of this small probe oscillates at 23 kHz with such a large amplitude that it pulverizes tissue on contact. The debris is then aspirated. The speed of the tip may exceed the speed of sound in tissue, thus creating shock waves and cavitation, rather than a smooth simple harmonic oscillator-type wave.

Most of the energy carried by high-intensity ultrasound in tissue is converted to thermal energy. In fact, intensities of  $10^3$  to  $10^4$  W/m<sup>2</sup> are commonly used for deep-heat treatments called ultrasound diathermy. Frequencies of 0.8 to 1 MHz are typical. In both athletics and physical therapy, ultrasound diathermy is most often applied to injured or overworked muscles to relieve pain and improve flexibility. Skill is needed by the therapist to avoid “bone burns” and other tissue damage caused by overheating and cavitation, sometimes made worse by reflection and focusing of the ultrasound by joint and bone tissue.

### Ultrasound in Medical Diagnostics

When used for imaging, ultrasonic waves are emitted from a transducer, a crystal exhibiting the piezoelectric effect (the expansion and contraction of a substance when a voltage is applied across it, causing a vibration of the crystal). These high-frequency vibrations are transmitted into any tissue in contact with the transducer. Similarly, if a pressure is applied to the crystal (in the form of a wave reflected off tissue layers), a voltage is produced which can be recorded. The crystal therefore acts as both a transmitter and a receiver of sound. Ultrasound is also partially absorbed by tissue on its path, both on its journey away from the transducer and on its return journey. From the time between when the original signal is sent and when the reflections from various boundaries between media are received, (as well as a measure of the intensity loss of the signal), the nature and position of each boundary between tissues and organs may be deduced.

Reflections at boundaries between two different media occur because of differences in a characteristic known as the **acoustic impedance**  $Z$  of each substance. Impedance is defined as

$$Z = \rho v,$$

where  $\rho$  is the density of the medium (in kg/m<sup>3</sup>) and  $v$  is the speed of sound through the medium (in m/s). The units for  $Z$  are therefore kg/(m<sup>2</sup> · s).

Medium	Acoustic Impedance (kg/m <sup>2</sup> s)
Air	429
Brain	$1.58 \times 10^6$
Soft tissue	$1.63 \times 10^6$
Skin	$1.63 \times 10^6$
Water	$1.58 \times 10^6$
Bone	$7.80 \times 10^6$
Blood	$1.66 \times 10^6$



The applications of ultrasound in medical diagnostics have produced untold benefits with no known risks. Diagnostic intensities are too low (about  $10^{-2} \text{ W/m}^2$ ) to cause thermal damage. More significantly, ultrasound has been in use for several decades and detailed follow-up studies do not show evidence of ill effects, quite unlike the case for x-rays.

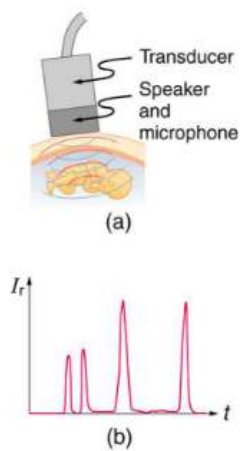

**Figure 3.** (a) An ultrasound speaker doubles as a microphone. Brief bleeps are broadcast, and echoes are recorded from various depths. (b) Graph of echo intensity versus time. The time for echoes to return is directly proportional to the distance of the reflector, yielding this information noninvasively.

The most common ultrasound applications produce an image like that shown below. The speaker-microphone broadcasts a directional beam, sweeping the beam across the area of interest. This is accomplished by having multiple ultrasound sources in the probe's head, which are phased to interfere constructively in a given, adjustable direction. Echoes are measured as a function of position as well as depth. A computer constructs an image that reveals the shape and density of internal structures.



Whenever a wave is used as a probe, it is very difficult to detect details smaller than its wavelength  $\lambda$ . Indeed, current technology cannot do quite this well. Abdominal scans may use a 7-MHz frequency, and the speed of sound in tissue is about 1540 m/s—so the wavelength limit to detail would be  $\lambda = \frac{v_w}{f} = \frac{1540 \text{ m/s}}{7 \times 10^6 \text{ Hz}} = 0.22 \text{ mm}$ . In practice, 1-mm detail is attainable, which is sufficient for many purposes. Higher-frequency ultrasound would allow greater detail, but it does not penetrate as well as lower frequencies do. The accepted rule of thumb is that you can effectively scan to a depth of about  $500\lambda$  into tissue. For 7 MHz, this penetration limit is  $500 \times 0.22 \text{ mm}$ , which is 0.11 m. Higher frequencies may be employed in smaller organs, such as the eye, but are not practical for looking deep into the body.

- (a) What is the relationship between ultrasound frequency and the size of structures that can be detected using ultrasound technology. (1 mark)

---

---

---

- (b) When used to destroy tumors, the ultrasound transducer is inserted into the body on the tip of a needle rather than placing the transducer on the skin near the tumor. State a reason for this. (1 marks)

---

---

---

- (c) An ultrasound transducer utilizes the *piezoelectric effect*. Explain how using this effect, the transducer can act as a transmitter and receiver of ultrasound. (3 marks)

---

---

---

---

---

- (d) Describe how ultrasound can be used to distinguish between different types of tissue in the body. (2 marks)

---

---

---

- (e) In the human liver, sound travels at  $1570 \text{ m s}^{-1}$  and the density of the liver is  $1050 \text{ kg m}^{-3}$ , calculate the acoustic impedance for liver and hence determine whether or not a pool of blood near the liver would be readily identified using ultrasound techniques. (3 marks)

---

---

---



- (f) When an ultrasound transducer is placed on the skin, a gel is used to provide lubricant for the probe to smoothly move over the patient's skin.

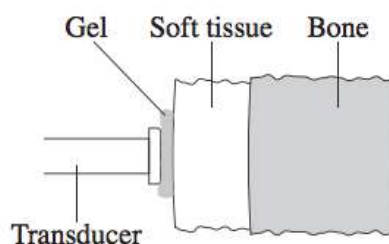

What would be an ideal value for the acoustic impedance of the gel? Explain. (2 marks)

- (g) Identify the following statements as true (T) or false (F) (3 marks)

Ultrasound waves are <i>transverse waves</i>	
Compared to low frequency ultrasound, high frequency ultrasound has increased intensity but poorer penetration.	
A collection of water in the brain would be easily identified with ultrasound techniques.	

### Question 21

(15 marks)

Read the following article and then answer the questions that follow.

## Positron Emission Tomography (PET)

Article adapted from *College Physics* ISBN-10: 1938168003 and *Institute of Physics* article on PET ([http://www.iop.org/education/teacher/resources/teaching-medical-physics/positron/page\\_56317.html](http://www.iop.org/education/teacher/resources/teaching-medical-physics/positron/page_56317.html))

Images produced by  $\beta^+$  emitters have become important in recent years. When the emitted positron ( $\beta^+$ ) encounters an electron, mutual annihilation occurs, producing two  $\gamma$  rays. These  $\gamma$  rays have identical 0.511 MeV energies (the energy comes from the destruction of an electron or positron mass) and they move directly away from one another, allowing detectors to determine their point of origin accurately, as shown below. The system is called positron emission tomography (PET). It requires detectors on opposite sides to simultaneously (i.e., at the same time) detect photons of 0.512 MeV energy and utilizes computer imaging techniques. Examples of  $\beta^+$ -emitting isotopes used in PET are C-11, N-13, O-15,

and F-18. The accuracy and sensitivity of PET scans make them useful for examining the brain's anatomy and function. The brain's use of oxygen and water can be monitored with O-15. PET is used extensively for diagnosing brain disorders. It can note decreased metabolism in certain regions prior to a confirmation of Alzheimer's disease. PET can locate regions in the brain that become active when a person carries out specific activities, such as speaking, closing their eyes, and so on.

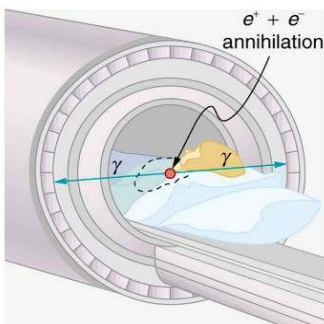

A PET system takes advantage of the two identical  $\gamma$ -ray photons produced by positron-electron annihilation. These  $\gamma$  rays are emitted in opposite directions, so that the line along which each pair is emitted is determined. Various events detected by several pairs of detectors are then analyzed by the computer to form an accurate image.

**PET imaging**

PET imaging carried out by injecting patient with a tracer that produces gamma rays (indirectly). Gamma rays detected using ring of detectors around patient. Signal from detectors used by computer to build a functional image of organs such as the brain.

### Making Radiotracers.

The radiotracer fluorine-18 is made using a particle accelerator (cyclotron). Protons must be accelerated to very high speed in order to overcome repulsion of positively charged target nuclei. Fluorine-18 can be used to make radioactive glucose, which is preferentially taken up by brain and cancer cells.

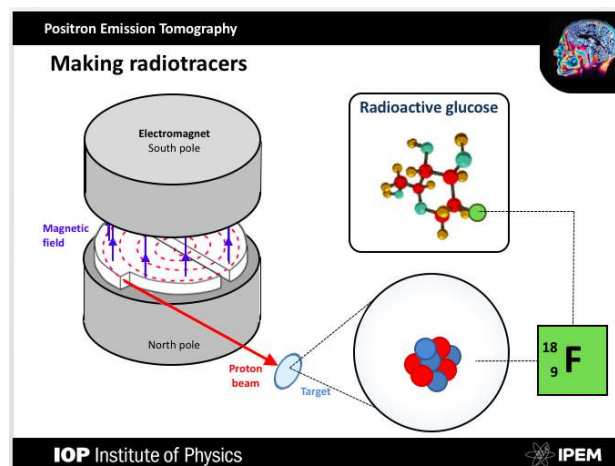

### Positron Emission

Unstable (light) nuclei have either too many protons or too many neutrons to be stable. Neutron-rich Isotopes undergo beta-minus decay; a neutron changes to a proton inside the nucleus and a negatively charged electron is emitted. Proton-rich Isotopes can undergo beta-plus decay; a proton changes to a neutron inside the nucleus and positively charged antimatter counterpart of electron (positron) is emitted

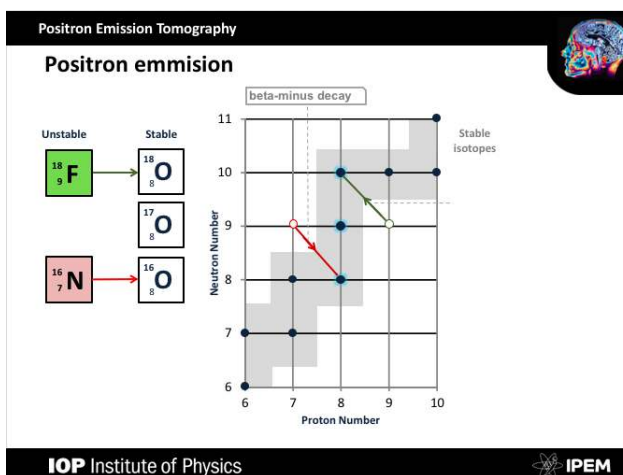

### Gamma Pair Production

After being emitted, positron slows down (after travelling about 1 mm) and interacts with an electron inside the patient's body. Annihilation of the electron and positron produces two gamma rays travelling in opposite directions. Gamma rays that do not arrive in pairs are ignored. A Computer works out position of source by "drawing lines" between gamma rays that arrive at the same time (within nanoseconds of each other). Gamma rays produced must travel in opposite directions to conserve momentum (both electron and positron have negligible momentum before annihilation)

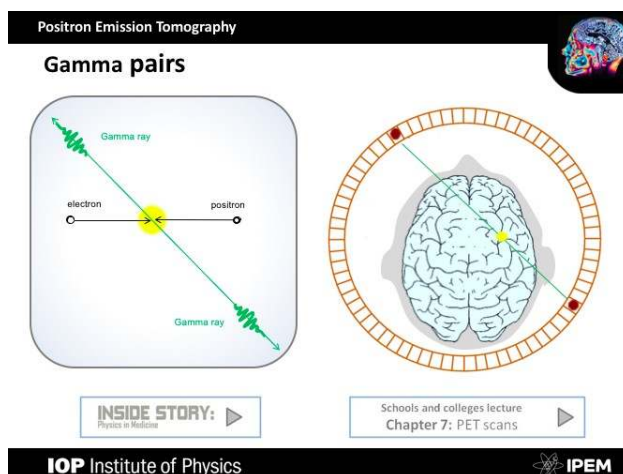

(a) Different isotopes of fluorine are shown below.

Isotope	Stability
Fluorine-18	Unstable, beta plus decay
Fluorine-19	Stable,
Fluorine-20	Unstable, beta minus decay

(i) Why is fluorine useful for making a radiotracer? (1 mark)

(ii) The isotope used in PET is fluorine-18. Explain why the other isotopes of fluorine listed above are not suitable for PET. (2 marks)

---



---



---

(b) The radioactive isotope carbon-11 used in PET is produced by firing high speed protons at nitrogen atoms.

(i) Why do the protons need to be travelling at high speed? (1 mark)

(ii) The nuclear reaction for the production of carbon-11 is shown below. Identify the particle (X) emitted in this process. (1 marks)

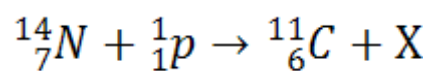

(c) The diagram below shows a slice of lemon in a (very small) PET scanner.

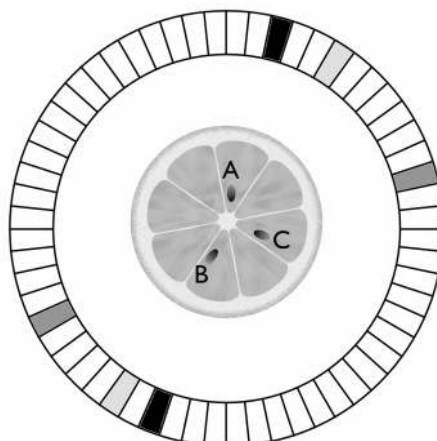

**One** of the pips in the lemon is radioactive and is emitting positrons. Detectors shaded with the same shade of grey show pairs of gamma rays detected at the same time.

- (i) Which one of the pips is radioactive? Explain your choice. (2 marks)

- (ii) How are these gamma rays created after a positron is emitted? (2 marks)

- (iii) Why do the gamma rays travel in opposite directions? (2 marks)

- (d) The article states that the X-rays produced in PET have identical energies of 0.511 MeV. Show that this is indeed the case when an electron and its antimatter equivalent (a positron) are converted to energy. (4 marks)

End of Questions

Additional Working Space





